

SIEMENS

Ingenuity for life



SINAMICS V20

The cost-effective, reliable
and easy-to-use converter for
basic applications

[siemens.com/sinamics-v20](https://www.siemens.com/sinamics-v20)

SINAMICS V20

The perfect solution for basic applications

SINAMICS V20, the versatile converter for basic demands

Today, in an increasing number of applications in plant and machinery construction, individual automation and drive solutions are demanded that automate simple motion sequences with low associated requirements.

With its compact SINAMICS V20, the basic performance converter, Siemens offers a simple and cost-effective drive solution for these types of applications. SINAMICS V20 sets itself apart with its quick commissioning times, ease of operation, robustness and cost efficiency.

With seven frame sizes, it covers a power range extending from 0.12 kW up to 30 kW (1/6 hp up to 40 hp).

Minimize your costs

Engineering, commissioning and operating costs must be kept as low as possible. You have precisely the right solution with our SINAMICS V20. To increase energy efficiency, the converter is equipped with control technology designed to achieve optimum energy efficiency through automatic flux reduction. Not only this, it displays the actual energy consumption and has additional, integrated energy-saving functions. This allows energy consumption to be slashed drastically.

Highlights

Easy to install

- Push-through and wall mounting – side-by-side possible for both
- USS and MODBUS RTU at terminals
- Integrated braking chopper for 7.5 kW to 30 kW (10 hp up to 40 hp)
- Electromagnetic compatibility (EMC) category C1/C2

Easy to use

- Parameter loading without power supply
- Easy commissioning with mobile device or laptop with web server module SINAMICS V20 Smart Access
- Integrated application and connection macros
- Keep Running mode for uninterrupted operation
- Wide voltage range, advanced cooling design and coated PCBs increase robustness

Easy to save money

- ECO mode for V/f, V²/f / Hibernation
- Monitoring energy and water flows
- High overload and low overload mode for FSE

Power range 0.12 kW to 30 kW
(1/6 hp to 40 hp)

Voltage range 1AC 200 V ... 240 V (–10% / +10%)^{1), 2)}
3AC 380 V ... 480 V (–15% / +10%)

Control modes V/f V²/f FCC V/f multi-point

¹⁾ Single-phase devices can also be connected to two phases of a 3-phase 120/240 V supply system. The voltage between L1 and L2 should be in the range of 200 V to 240 V, –10% to +10% (whether phase to phase or phase to neutral).

You can find detailed information here:
<http://support.industry.siemens.com/cs/document/109476260>

²⁾ Voltage tolerance for FSAA/FSAB (–15% / +10%)



Typical applications

Pumping, ventilating and compressing

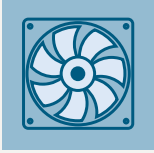

- Centrifugal pumps
- Radial/axial fans
- Compressors
- ...

Additional advantages:

- High availability through automatic restart and flying restart after power failures
- Broken belt detection by monitoring the load torque
- Pump protection against cavitation
- Hammer start and blockage clearing modes for clogged pumps
- PID controller for process values (e.g. temperature, pressure, level, flow)
- PID auto tuning to optimize controller parameters
- Hibernation mode stops the motor when demand is low
- Motor staging extends the flow range by adding two more fixed-speed drives (cascade)
- Frost and condensation protection prevents moisture in motors under extreme environmental conditions



Moving

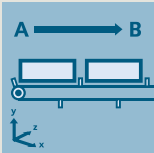

- Belt conveyors
- Roller conveyors
- Chain conveyors
- Bucket conveyors
- Treadmills
- ...

Additional advantages:

- Soft, jerk-free acceleration reduces the stress on the gear units, bearings, drums and rollers
- Super torque start for conveyor belts with high breakaway torque
- Dynamic behavior by using braking resistor or DC braking
- Direct control of mechanical holding brake
- Broken belt detection by monitoring the load torque
- Precise stopping with Quick Stop (switch-off positioning) independently from the control cycle



Processing

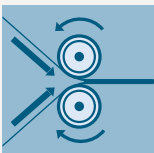

- **Single drives in the process industry** such as mills, mixers, kneaders, crushers, mechanical presses, agitators, centrifuges
- **Single drives in commercial appliances** such as kitchen ovens, mixers, washing machines

Additional advantages:

- Frost and condensation protection prevents moisture in motors under extreme environmental conditions
- Higher productivity without interruptions due to Keep Running mode
- Exchange of regenerative energy via the DC link
- Super torque start for machines with a high breakaway torque



- **Main drives in machines with mechanically coupled axes** such as ring spinning machines, braiding machines for textiles, ropes and cables

Easy to install

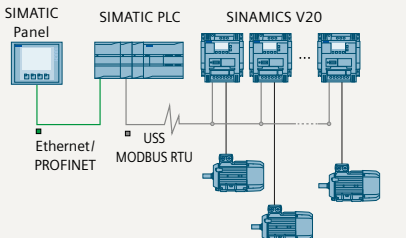
	SINAMICS V20 feature	Your benefits
<p>Easy, and all from a single source</p> 	<p>Together with SIMATIC PLC/HMI, tested and ready-to-run application examples to connect a V20 converter to a controller.</p>	<ul style="list-style-type: none"> • Different application examples can be downloaded free of charge from the online support portal. For more information, also see page 8 or go directly to http://siemens.com/sinamics-applications

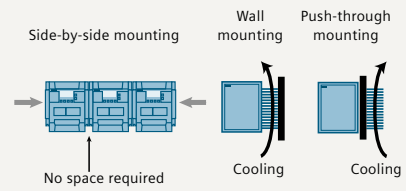
Installation		
	<p>Compact design, side-by-side mounting and flexible device installation for both wall mounting and push-through mounting.</p> <p>Operation without additional option modules possible.</p>	<ul style="list-style-type: none"> • Compact installation allows smaller cabinets to be used • Push-through mounting allows the cabinet to be cooled more easily • Can be run “out-of-the-box” without other options • Basic operator actions at a built-in BOP (Basic Operator Panel) • Frame sizes FSAA and FSAB (1AC 230 V) 24% smaller compared to previous frame size FSA within the same power range

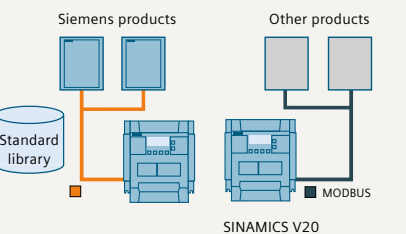
Communication		
	<p>The communication port is available at the terminals. The preset parameters of the USS and MODBUS RTU are defined in the connection macro.</p>	<ul style="list-style-type: none"> • Easy integration into existing systems • Easy integration into micro automation systems • Easier commissioning through standard libraries and connection macros • Full flexibility of MODBUS RTU settings to communicate with controller • Simple connection to a control system (SIMATIC PLC)

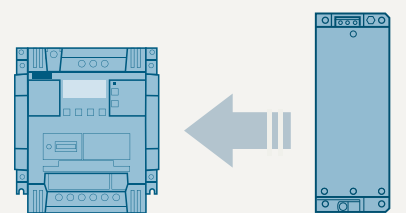
EMC category C1		
	<p>SINAMICS V20 in frame sizes FSAA and FSAB, 1AC 230 V with integrated category C1 EMC filter.</p>	<ul style="list-style-type: none"> • Optionally, the devices are available with integrated radio interference filter, which provides compliance with disturbance limits according to IEC 61800-3 category C1 when installed according to EMC (electromagnetic compatibility) in the cabinet. Consequently, the frame sizes FSAA and FSAB comply with the disturbance requirements of industrial applications as well as with applications for residential and business areas, for example, commercial use such as refrigerated counters, workout devices, ventilation systems, commercial washing machines, etc.

Easy to use

	SINAMICS V20 feature	Your benefits
Parameter cloning		
<p>Parameter loading</p> <p>Commissioning Copy configuration</p>	<p>Parameter settings can be easily transferred from one unit to another even without power supply by using the parameter loader. Even the latest firmware version may be loaded to the converter.</p>	<ul style="list-style-type: none"> • Less technical support required • Short commissioning time • The product is delivered to the customer already preset
SINAMICS V20 Smart Access		
<p>SINAMICS V20 Smart Access Mobile devices</p>	<p>Wireless commissioning, operation and diagnostics via mobile device or laptop with web server module SINAMICS V20 Smart Access (option)</p>	<ul style="list-style-type: none"> • Provides easy access to the converter even if it is located in difficult-to-access areas • Easy operation due to intuitive web user interface and commissioning wizard • Full flexibility in choosing your end device for engineering as the SINAMICS V20 Smart Access is a web server approach that works with any operating system and any HTML5 capable web browser
Macro approach		
<p>Fan Macro SINAMICS V20</p>	<p>Connection and application macros to simplify I/O configuration and provide appropriate settings.</p>	<ul style="list-style-type: none"> • Shorter training and commissioning time • Integrated and optimized application setting • Simple connection and application macros can be selected to avoid lengthy configurations and complicated parameter lists • Errors caused by wrong parameter settings can be avoided
Keep Running mode		
<p>SINAMICS V20 Motor</p>	<p>The function enables higher productivity through automatic adaptation in the case of unstable line supply.</p>	<ul style="list-style-type: none"> • Stable operation under difficult line supply conditions • Higher productivity through prevention of interruptions of the production line • Adaptation to application-relevant reactions through flexible definition in case of fault/alarm
Robustness		
<p>SINAMICS V20 Motor</p>	<p>Wider voltage range, better cooling design and coated PCB increase robustness of the drive in difficult environments.</p>	<ul style="list-style-type: none"> • Operation possible when the line supply voltage fluctuates • Reliable operation for line voltages: <ul style="list-style-type: none"> – 1AC 200 V ... 240 V (-10% / +10%)¹⁾ – 3AC 380 V ... 480 V (-15% / +10%) • Operation at ambient temperatures between -10 °C and 60 °C

¹⁾Voltage tolerance for FSAA/FSAB (-15%, +10%)

Easy to save money

SINAMICS V20 feature Your benefits

ECO mode / Hibernation mode – Energy reduction during operation and standby

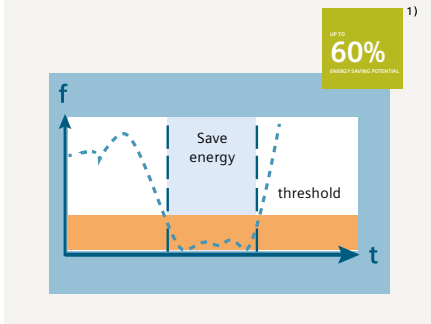

Integrated ECO mode for V/f and V²/f automatically adapts the flux to save energy. The energy consumption can be shown in kWh, CO₂ or even in the local currency.

Hibernation mode, converter and motor are only activated when used by the plant or machine.

- ECO mode:**
- Energy saving during low dynamic load cycles
 - Tells end users the actual energy that has been saved
- Hibernation mode:**
- Smart hibernation saves energy
 - Extended lifetime of motor

Integrated energy and water flow monitoring

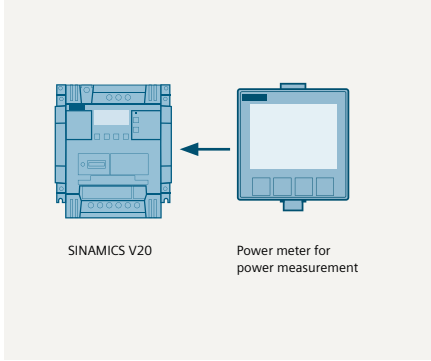

Energy consumption and savings are monitored without the need for power measurement equipment.

- Intuitive values for power consumption and savings without additional investments for measurement equipment
- Values can be shown as kWh, CO₂ or as a currency

Cost savings for low overload applications

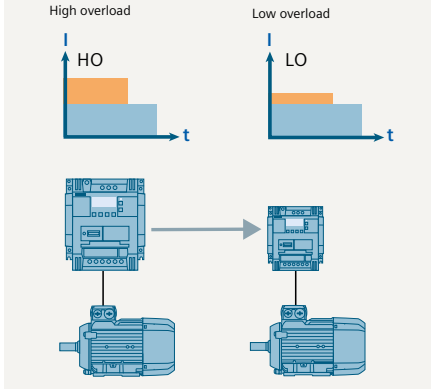

SINAMICS V20 FSE (22 kW and 30 kW) have two different load cycles.

- Low overload (LO): 110% I_L² for 60 s (cycle time: 300 s)
- High overload (HO): 150% I_H³ for 60 s (cycle time: 300 s)

- With the low overload cycle, the converter can reach a higher output current and power. A smaller converter can be used.
- Optimally designed for variable applications:
 - Low overload for applications with a low dynamic response (continuous duty)
 - High overload for applications with a high dynamic response (cyclic duty)

¹⁾ Application and machine-type dependent.
²⁾ The output current I_L is based on the duty cycle for low overload (LO).
³⁾ The output current I_H is based on the duty cycle for high overload (HO).

Integrated and innovative support

DT Configurator – fast product selection and ordering



The DT Configurator supports you with:

- Selecting the best drive based on the application
- The subsequent ordering process

The DT Configurator supplies you with:

- A drive that is optimally tailored to your requirements
- 2D dimensional drawing
- 3D models
- Data sheets
- EPLAN macros

You can directly order the selected components through the Industry Mall – the Siemens e-commerce website – and without having to duplicate entries. In order to avoid making mistakes while ordering, the order number is checked to ensure that it is correct.

Link to Internet page:

<https://siemens.com/dt-configurator>

Industry Mall – comprehensive online information and services



The Industry Mall supports you with:

- Selecting products, services and trainings

The Industry Mall supplies you with:

- A complete and up-to-date Siemens automation and drive technology product spectrum
- System configuration
- Download of CAX data, data sheets and schematic diagrams
- Online shopping cart orders
- Price and order overview
- Availability check and order tracking

Link to Internet page:

<https://mall.industry.siemens.com>

Complete motion control solutions from Siemens

SINAMICS V20 and SIMATIC – Siemens offers comprehensive solutions from a single source for general motion control applications. Through the optimized interaction between SIMATIC control and SINAMICS drive technology, as shown in our “SINAMICS Application Examples,” we can provide you with highly efficient systems.

Siemens application examples comprise:

- Ready-to-run application examples, including wiring diagrams, parameter descriptions
- Sample configurations for connecting SINAMICS with SIMATIC, including hardware, software and wiring examples, installation instructions for the supplied S7 project, drive parameterization, and HMI sample projects

Customer benefits:

- Provides a basis for customer-specific configurations
- Optimal leveraging of TIA advantages
- Free download via the Online Support Portal:
<https://siemens.com/sinamics-applications>

Example: Speed control of a V20 with S7-1200 (TIA Portal) via USS® protocol/MODBUS RTU with HMI

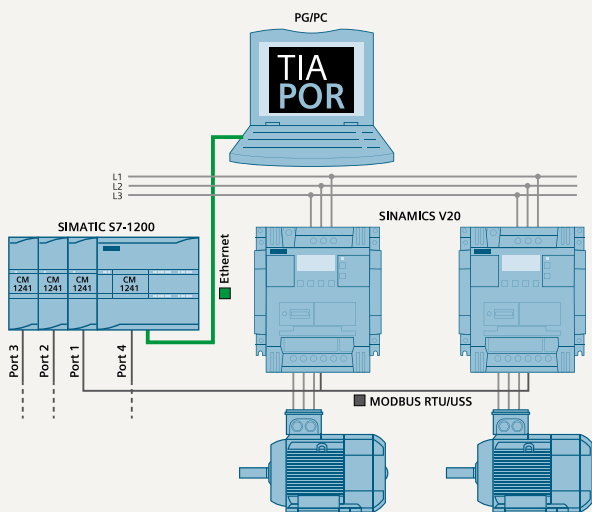

Task

USS communication

- Cyclic write/read access of a SIMATIC S7-1200 to selected SINAMICS V20 process/control data, the transmission of which is supported by a STEP 7 instruction
- Connections of up to 64 drives are possible

MODBUS communication

- Cyclic write/read access of a SIMATIC S7-1200 to selected SINAMICS V20 process/control data that can be triggered via a STEP 7 instruction via MODBUS register numbers

Solution

With up to three communication modules CM1241 added to the SIMATIC S7-1200 and one communication board CB1241, a USS® or MODBUS communication can be established to SINAMICS V20 drives.

USS communication

- Up to 16 drives can be operated per port. The user function blocks use STEP 7 instructions USS_PORT, USS_DRV, USS_RPM and USS_WPM

MODBUS communication

- Up to 32 drives can be operated per port (with repeaters, up to 247). The user function blocks use the STEP 7 instructions MB_COMM_LOAD and MB_MASTER

Link to Internet page:

<https://siemens.com/sinamics-applications>

Overload capability characteristics

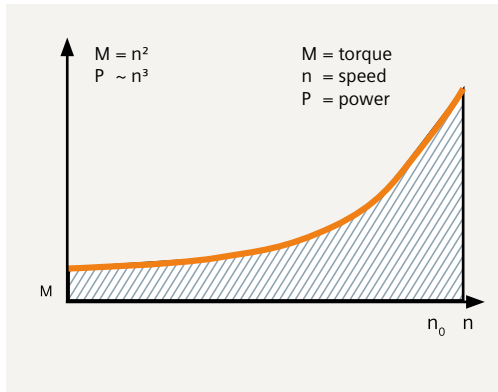

Low overload (LO) is generally used for applications demanding a low level of dynamic performance (continuous duty), square-law torque characteristic with low breakaway torque and low speed precision.

For example: centrifugal pumps, radial/axial fans, reciprocating blowers, radial compressors, vacuum pumps, agitators, ...

Overload capability

Low overload (LO) 110% $I_L^{1)}$ for 60 s within a cycle time of 300 s

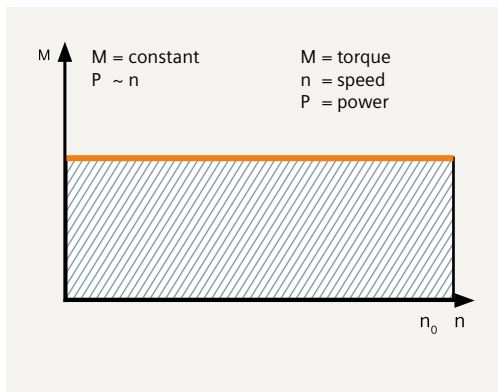

High overload (HO) is generally used for applications demanding a higher dynamic performance (cyclic duty) as well as constant torque characteristics with a high breakaway torque.

For example: conveyor belts, geared pumps, eccentric worm pumps, mills, mixers, crushers, vertical conveying equipment, centrifuges, ...

Overload capability

High overload (HO) 150% $I_H^{2)}$ for 60 s within a cycle time of 300 s

¹⁾ The output current I_L is based on the duty cycle for low overload (LO).
²⁾ The output current I_H is based on the duty cycle for high overload (HO).

Easy accessibility from outside the cabinet.



V20 BOP (Basic Operator Panel)



V20 BOP Interface



Frame size FSAA

Wireless commissioning and operation with web server module.



V20 Smart Access **New**



Cell phone

Technical data



Power and control	
Voltage	1AC 230 V: 1AC 200 V ... 240 V (-10% / +10%) ³⁾ 3AC 400 V: 3AC 380 V ... 480 V (-15% / +10%)
Maximum output voltage	100% of input voltage
Supply frequency	50 / 60 Hz
Line supply type	TN, TT, TT earthed line, IT ¹⁾
Power range	1AC 230 V 0.12 ... 3.0 kW (1/6 ... 4 hp) 3AC 400 V 0.37 ... 30 kW (1/2 ... 40 hp)
cos φ / Power factor	≥ 0.95 / 0.72
Overload capability	Up to 15 kW: High overload (HO): 150% I _N for 60 s within a cycle time of 300 s From 18.5 kW: Low overload (LO): 110% I _N for 60 s within a cycle time of 300 s High overload (HO): 150% I _N for 60 s within a cycle time of 300 s
Output frequency	0 ... 550 Hz resolution: 0.01 Hz
Efficiency factor	98%
Control modes	Voltage / frequency control mode: linear V/f, square law V/f, multi-point V/f Flux current control mode: FCC
Standards	
Standards	CE, cULus, RCM, KC
EMC standards, limit values for disturbance voltage (conducted emissions) and radiated emissions when installed according to EMC requirements	EN 61800-3 category C1, 1st environment: • 1AC 230 V 0.12 to 0.75 kW with integrated radio interference filter or unfiltered with external radio interference filter, shielded cables ≤ 5 m EN 61800-3 category C2, 1st environment: • 1AC 230 V 1.1 to 3 kW with integrated radio interference filter, shielded cables ≤ 25 m • 3AC 400 V without integrated radio interference filter with external line filter, shielded cables, FSA ²⁾ up to FSE ≤ 25 m EN 61800-3, category C3, 2nd environment: • 3AC 400 V with integrated radio interference filter, shielded cables, FSA ≤ 10 m, FSB up to FSD ≤ 25 m, FSE ≤ 50 m
Features	
Energy saving	<ul style="list-style-type: none"> • ECO mode • Hibernation mode • Energy consumption monitoring
Ease of use	<ul style="list-style-type: none"> • Connection and application macro • Parameter cloning • Web server module for wireless commissioning, operation, diagnostics and maintenance (option) • Keep running mode • USS/MODBUS RTU communication • Customized default value • List of modified parameters • Converter status at fault • Automatic restart • Flying start • DC-link voltage control • I_{max} control
Applications	<ul style="list-style-type: none"> • PID controller • BICO function • Hammer start • Super torque mode • Blockage clearing mode • Motor staging • Flexible boost control • Wobble function • Slip compensation • Dual ramp • Adjustable PWM modulation
Protection	<ul style="list-style-type: none"> • Frost protection • Condensation protection • Cavitation protection • Kinetic buffering • Load failure detection

¹⁾ 1AC 230 V FSAA/AB unfiltered devices as well as 3AC 400 V unfiltered devices, can be operated on an IT network.

²⁾ To achieve 25 m shielded motor cable length also with FSA, unfiltered devices with external filter have to be used.

³⁾ Single-phase devices can also be connected to two phases of a 3-phase 120/240 V supply system. The voltage between L1 and L2 should be in the range of 200 V to 240 V -10% to +10% (either phase to phase or phase to neutral).

You can find detailed information here: <http://support.industry.siemens.com/cs/document/109476260>

Signal inputs and outputs

Analog inputs	AI1: bipolar current / voltage mode, 12-bit resolution AI2: unipolar current / voltage mode, 12-bit resolution Can be used as digital inputs
Analog outputs	AO1: 0 ... 20 mA
Digital inputs	DI1 to DI4, optically isolated PNP/NPN selectable by terminal
Digital outputs	DO1: transistor output DO2: relay output – 250 V AC 0.5 A with resistive load – 30 V DC 0.5 A with resistive load

Connection diagram

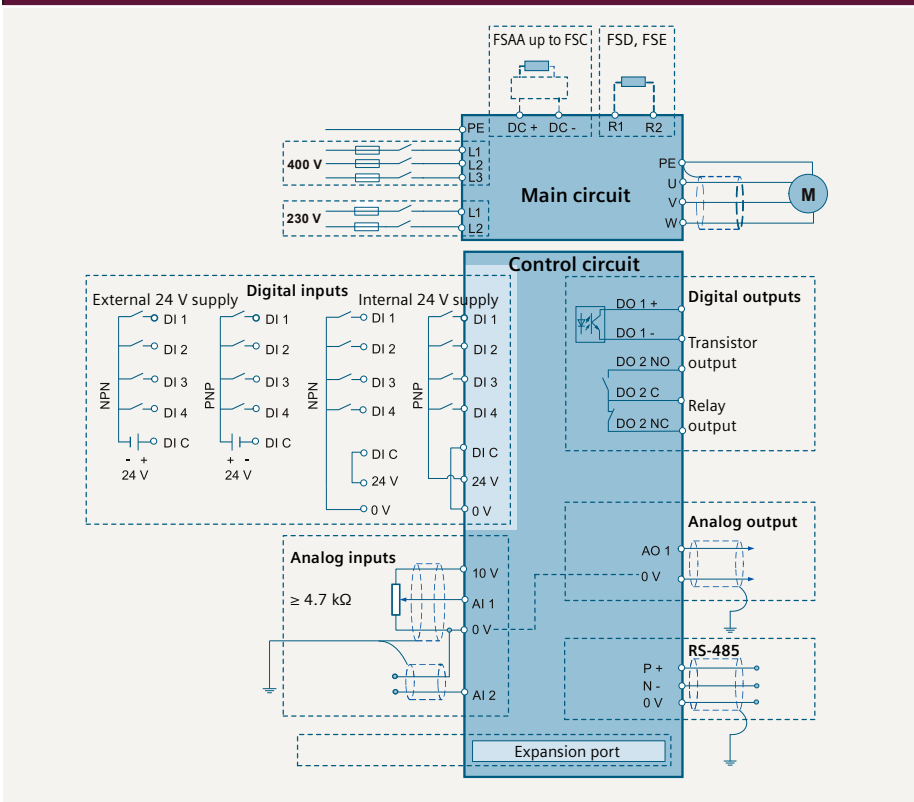

Mounting and environment

Degree of protection	IP20
Mounting	Wall mounting, side-by-side mounting, push-through mounting for FSB, FSC, FSD and FSE
Cooling	<ul style="list-style-type: none"> 0.12 to 0.75 kW: convection cooling All frame size: power electronics cooled using heat sinks with external fan
Surrounding temperature	<p>In operation</p> <ul style="list-style-type: none"> -10 ... 60 °C (14 ... 140 °F) 40 ... 60 °C (104 ... 140 °F) with derating <p>In storage</p> <ul style="list-style-type: none"> -40 ... 70 °C (-40 ... 158 °F)
Relative humidity	95% (non-condensing)
Altitude	<ul style="list-style-type: none"> Up to 4000 m above sea level 1000 ... 4000 m: output current derating 2000 ... 4000 m: supply voltage derating
Motor cable length	<ul style="list-style-type: none"> Unshielded cable: 50 m for FSAA up to FSD, 100 m for FSE Shielded cable: 25 m for FSAA up to FSD, 50 m for FSE Longer motor cables possible with output reactor (see options)
Dynamic braking	Option module for FSAA to FSC; integrated for FSD and FSE

Dimensions

SINAMICS V20 device

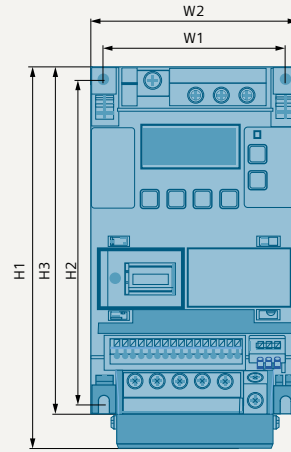
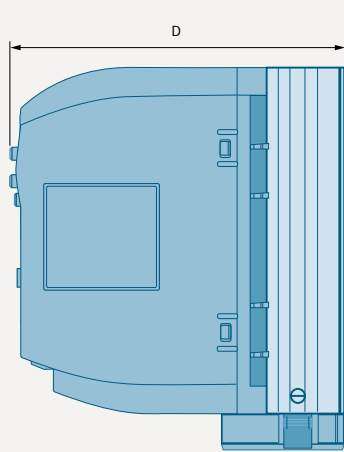

H1: Height with fan
H3: Height without fan

Frame size	Width (mm)		Height (mm)			Depth (mm)	Weight (kg)
	W1	W2	H1	H2	H3		
FSAA	58	68	–	132	142	107.8	0.7
FSAB	58	68	–	132	142	127.8	0.9
FSA	79	90	166	140	150	145.5	1.05
FSB	127	140	160	135	–	164.5	1.8
FSC	170	184	182	140	–	169	2.6
FSD	223	240	206.5	166	–	172.5	4.3
FSE	228	245	264.5	206	–	209	6.6

V20 BOP (Basic Operator Panel)

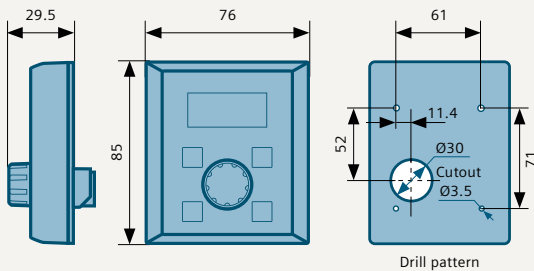

Drill pattern

V20 BOP (Basic Operator Panel) interface

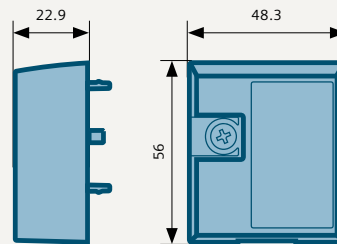

V20 Smart Access (web server module)

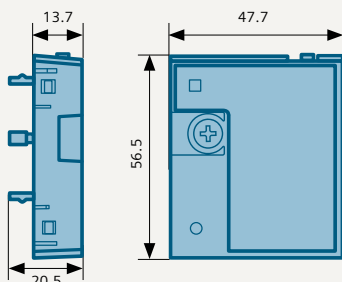

V20 Parameter loader

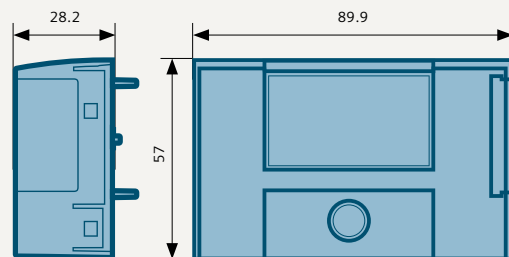

1AC 200 V ... 240 V options

P _{rated} (HO) kW 1AC 230 V	FS	Braking resistors				Line reactors				Output reactors				Braking module				Line filter class B				
		W	H	D	WT	W	H	D	WT	W	H	D	WT	W	H	D	WT	W	H	D	WT	
0.12	AA	72	230	43.5	1	75.5	200	50	0.5	75	200	50	1.3	90	150	88	0.71	73	200	43.5	0.5	
0.25																						
0.37																						
0.55																						
0.75																						
1.1	B	149	239		1.6	150	213		1.2	150	213	80	4.1									
1.5																						
2.2	C																					
3																						
		185	285	150	3.8	185	245		1.0	185	245		6.6									

3AC 380 V ... 480 V options

P _{rated} (LO) kW 3AC 400 V	FS	Braking resistors				Line reactors				Output reactors				Braking module				Line filter class B			
		W	H	D	WT	W	H	D	WT	W	H	D	WT	W	H	D	WT	W	H	D	WT
0.37	A	105	295	100	1.48	125	120	71	1.1	178	175	73	3.4	90	150	80	0.71	73	202	65	1.75
0.55																					
0.75																					
1.1																					
1.5																					
2.2	B	105	345	100	1.80	125	140	71	2.1	178	180	73	3.9								
3																					
4	C									243	215	100	10.1								
5.5																					
7.5	D					125	145	91	2.95	243	235	115	11.2	integrated							
11																					
15	E	250	490	140	6.20	190	220	81	7.8												
22																					
30																					
		270	515	175	7.4	275	455	84	13	225	210	150	10.7								
											179	16.1									

FS = frame size, WT = weight in kg, W = width in mm, H = height in mm, D = depth in mm

We made it even smaller.
The smallest SINAMICS
converter saves on space –
not on what counts.

Frame size FSAA and FSAB,
1AC 230 V 0.12 to 0.75 kW
with integrated EMC filter



Frame size FSAA



Frame size FSAB

Full range of options

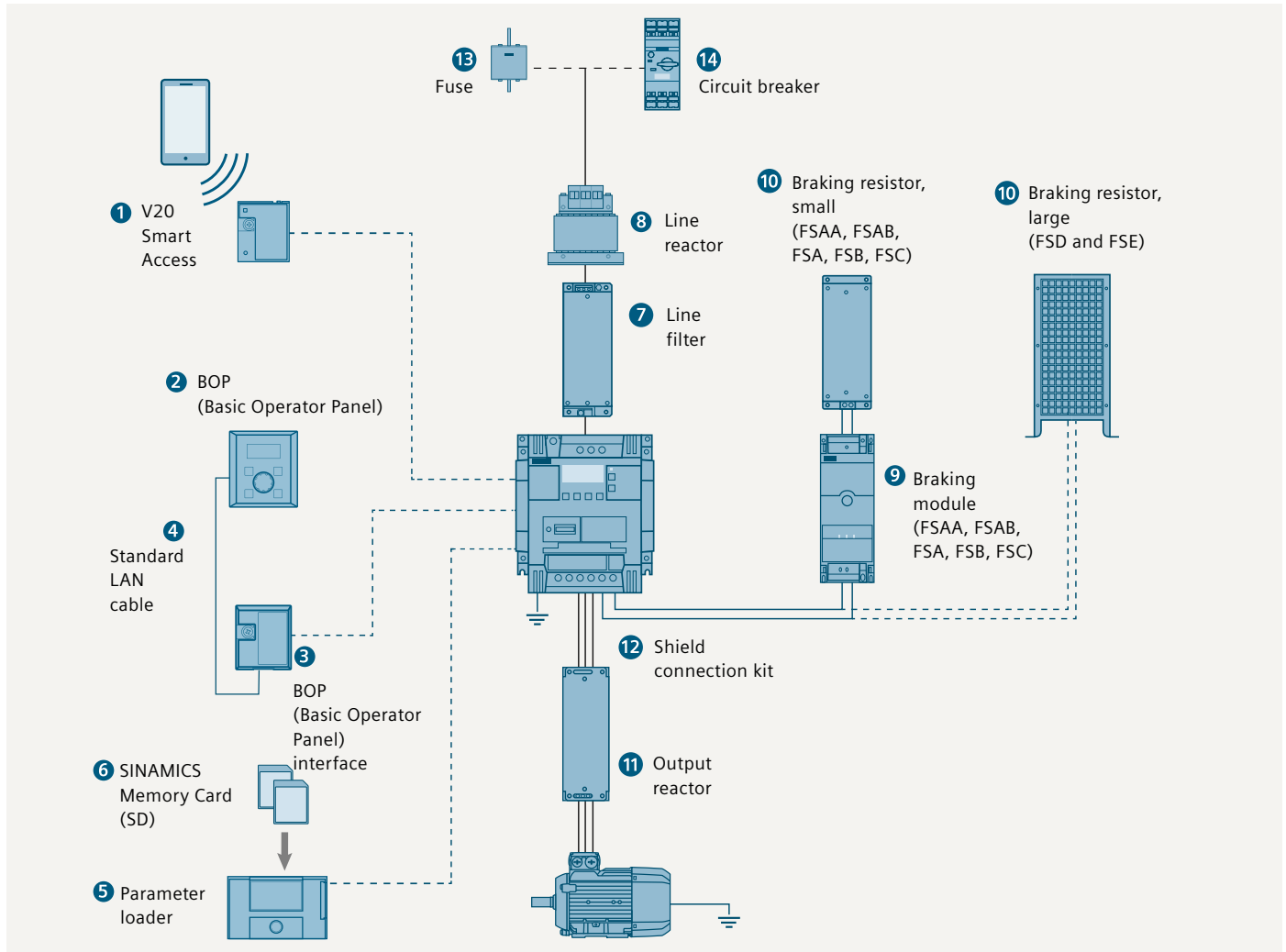

Options		
1	V20 Smart Access	Wireless commissioning, operation and diagnostics with mobile device or laptop with web server module
2	V20 BOP	Same function as the integrated BOP (Basic Operator Panel), but can be used for remote mounting. The value and setpoint are changed by rotating the wheel. For remote mounting with IP54 and UL Type 1 enclosure protection level from outside.
3	BOP interface	<ul style="list-style-type: none"> • Connection between converter and BOP • RJ45 interface is compatible with standard LAN cable
4	BOP cable	The cable is not included in the delivery. You can use any standard LAN cable with standard RJ45 connector.
5	Parameter loader	Up to 100 parameter settings can be written from the memory card (SD card up to 32 GB supported) to the converter or saved from the converter to the memory card without connecting the converter to the line supply.
6	SINAMICS Memory Card (SD)	Memory card (512 MB) (Standard SD cards up to 32 GB are supported)
7	Line filter	<ul style="list-style-type: none"> • Improved EMC performance • Longer motor cable for FSAA, FSAB, FSA

Options		
8	Line reactor	<ul style="list-style-type: none"> • Reduces the harmonic current • Improves the power factor • Recommended if input current (RMS value) is higher than the rated current of the converter
9	Braking module	<ul style="list-style-type: none"> • Shortens the deceleration ramp time • Suitable for 1AC 230 V and 3AC 400 V • Adjustable duty cycle from 5% to 100% • FSD and FSE already have an integrated braking unit
10	Braking resistor	<ul style="list-style-type: none"> • Dissipates regenerative energy as heat • 5% duty cycle as default setting
11	Output reactor	Longer motor cable: <ul style="list-style-type: none"> • 3AC 400 V shielded and unshielded cable: 150 m for FSA to FSD, 200 m/300 m for FSE • 1AC 230 V shielded and unshielded cable: 200 m
12	Shield connection kit	<ul style="list-style-type: none"> • Shield connection • Strain relief
13	Fuse	Recommended fuse corresponding to the IEC/UL standard
14	Circuit breaker	Recommended circuit breaker corresponding to the IEC/UL standard

1AC 200 V ... 240 V device¹⁾

Rated data					
P _{rated} (HO)		I _H	Article number	Fans	Frame size
kW	hp				
0.12	1/6	0.9	6SL3210-5BB11-2	V1 –	FSAA
0.25	1/3	1.7	6SL3210-5BB12-5	V1 –	
0.37	1/2	2.3	6SL3210-5BB13-7	V1 –	
0.55	3/4	3.2	6SL3210-5BB15-5	V1 –	FSAB
0.75	1	4.2	6SL3210-5BB17-5	V1 –	
1.1	1–1/2	6	6SL3210-5BB21-1	V0 1	FSB
1.5	2	7.8	6SL3210-5BB21-5	V0 1	
2.2	3	11	6SL3210-5BB22-2	V0 1	FSC
3	4	13.6	6SL3210-5BB23-0	V0 1	

EMC Standards	
Without integrated radio interference filter	U
With integrated radio interference filter category C2 ²⁾ (only available for FSB and FSC from 1.1 to 3 kW)	A
With integrated radio interference filter category C1 ³⁾ (only available for FSAA and FSAB up to 0.75 kW)	B

3AC 380 V ... 480 V device

Rated data					
P _{rated} (LO)		I _L 400 V ⁵⁾	I _L 480 V	P _{rated} (HO)	
kW	hp	A	A	kW	hp
0.37	1/2	1.3	1.3	0.37	1/2
0.55	3/4	1.7	1.7	0.55	3/4
0.75	1	2.2	2.2	0.75	1
1.1	1–1/2	3.1	3.1	1.1	1–1/2
1.5	2	4.1	4.1	1.5	2
2.2	3	5.6	4.8	2.2	3
3	4	7.3	7.3	3	4
4	5	8.8	8.24	4	5
5.5	7–1/2	12.5	11	5.5	7–1/2
7.5	10	16.5	16.5	7.5	10
11	15	25	21	11	15
15	20	31	31	15	20
22	30	45	40	18.5	25
30	40	60	52	22	30

EMC Standards	
Without integrated radio interference filter	
With integrated radio interference filter category C3 ⁴⁾	

1AC 200 V ... 240 V options

FS	P _{rated} (HO) kW	Braking resistor 6SE6400-...	Line reactor 6SE6400-...	Output reactor 6SE6400-...	Shield connection kit 6SL3266-...	Line filter class B ⁷⁾	Corresponding to the IEC standard		
							Standard fuse ⁸⁾		Circuit breaker ⁸⁾
							Current in A	Article No.	Article No.
FSAA	0.12	4BC05-0AA0	3CC00-4AB3	3TC00-4AD3	1AR00-0VA0	6SL3203-0BB21-8VA0	10	3NA3803	3RV2011-1DA10
	0.25								3RV2011-1FA10
	0.37								3RV2011-1HA10
FSAB	0.55	4BC11-2BA0	3CC01-0AB3	3TC01-0BD3	1AB00-0VA0	6SE6400-2FL02-6BB0	16	3NA3805	3RV2011-1JA10
	0.75								3RV2011-1KA10
FSB	1.1	4BC12-5CA0	3CC02-6BB3	3TC01-0BD3	1AB00-0VA0	6SE6400-2FL02-6BB0	20	3NA3807	3RV2021-4BA10
	1.5								3RV2021-4CA10
FSC	2.2	4BC12-5CA0	3CC03-5CB3	3TC03-2CD3	1AC00-0VA0	–	35	3NA3812	3RV2021-4EA10
	3								3NA3814
							50	3NA3820	3RV1031-4FA10

Accessories

Name	Article number
Parameter loader	6SL3255-0VE00-0UA1
V20 BOP (Basic Operator Panel)	6SL3255-0VA00-4BA1
BOP interface ⁹⁾ (Basic Operator Panel)	6SL3255-0VA00-2AA1
SINAMICS V20 Smart Access (web server module)	6SL3255-0VA00-5AA0 New
SINAMICS Memory Card (512 MB)	6SL3054-4AG00-2AA0
Braking module 1AC 230 V: 8 A; 3AC 400 V: 7 A	6SL3201-2AD20-8VA0
RS485 Terminators (Content 50 Pieces)	6SL3255-0VC00-0HA0
DIN Rail Mounting Kit	FSA/FSAA/FSAB: 6SL3261-1BA00-0AA0 ¹⁰⁾ FSB: 6SL3261-1BB00-0AA0
Migration Mounting Kit to fit FSAA/AB to former FSA	6SL3266-1ER00-0VA0
SINAMICS V20 Training case	6AG1067-2AA00-0AB6

Spare parts

Frame size	Article number
Replacement fan	
FSA	6SL3200-0UF01-0AA0
FSB	6SL3200-0UF02-0AA0
FSC	6SL3200-0UF03-0AA0
FSD	6SL3200-0UF04-0AA0
FSE	6SL3200-0UF05-0AA0

I _H 400 V ⁶⁾	I _H 480 V	Article number		Fans	Frame size
A	A				
1.3	1.3	6SL3210-5BE13-7	V0	–	FSA
1.7	1.7	6SL3210-5BE15-5	V0	–	
2.2	2.2	6SL3210-5BE17-5	V0	–	
3.1	3.1	6SL3210-5BE21-1	V0	1	
4.1	4.1	6SL3210-5BE21-5	V0	1	
5.6	4.8	6SL3210-5BE22-2	V0	1	FSB
7.3	7.3	6SL3210-5BE23-0	V0	1	
8.8	8.24	6SL3210-5BE24-0	V0	1	FSC
12.5	11	6SL3210-5BE25-5	V0	1	
16.5	16.5	6SL3210-5BE27-5	V0	2	
25	21	6SL3210-5BE31-1	V0	2	FSD
31	31	6SL3210-5BE31-5	V0	2	
38	34	6SL3210-5BE31-8	V0	2	FSE
45	40	6SL3210-5BE32-2	V0	2	

- Single-phase devices can also be connected to two phases of a 3-phase 120/240 V supply system. The voltage between L1 and L2 should be in the range of 200V to 240V -10% to +10% (whether phase to phase or phase to neutral). You can find detailed information here: <http://support.industry.siemens.com/cs/document/109476260>
- Disturbance suppression limits according to EN 61800-3 category C2 use in first environment (residential, domestic). The drive system must be installed by specialized personnel under consideration of regional regulations with respect to line harmonics.
- Disturbance suppression limits according to EN 61800-3 category C1 use in first environment (residential, domestic). The drive system must be installed by specialized personnel under consideration of regional regulations with respect to line harmonics.
- Disturbance suppression limits according to EN 61800-3 category C3 use in second environment (industry).
- The output current I_o is based on the duty cycle for low overload (LO).
- The output current I_H is based on the duty cycle for high overload (HO).
- See specifications for EMC standards, page 10.
- Additional information on listed fuses and circuit breakers can be found in Catalogs LV 10, IC 10 and IC 10 AO. <http://siemens.com/drives/infocenter>
- BOP interface and BOP integrated standard RJ45 connector compatible for standard Ethernet cable.
- For installation of FSA with fan, please refer to SINAMICS V20 manual. Installation of FSAA/AB, DIN rail mounting kit for FSA installation together with migration mounting kit.

3AC 380 V ... 480 V options

FS	P _{rated} (LO) kW	P _{rated} (HO) kW	Braking resistor 6SL3201-...	Line reactor 6SL3203-...	Output reactor 6SL3202-...	Shield connection kit 6SL3266-...	Line filter class B ⁷⁾ 6SL3203-...	Corresponding to the IEC standard		
								Standard fuse ⁸⁾		Circuit breaker ⁹⁾
								Current in A	Article No.	Article No.
FSA	0.37	0.37	0BE14-3AA0	0CE13-2AA0	0AE16-1CA0	1AA00-0VA0	0BE17-7BA0	6	3NA3801	3RV2011-1CA10
	0.55	0.55								3RV2011-1DA10
	0.75	0.75								3RV2011-1EA10
	1.1	1.1								3RV2011-1FA10
	1.5	1.5								3RV2011-1HA10
	2.2	2.2	0BE21-0AA0	0AE18-8CA0	10	3NA3803	3RV2011-1JA10			
FSB	3	3	0BE21-0AA0	0CE21-0AA0	0AE18-8CA0	1AB00-0VA0	0BE21-8BA0	16	3NA3805	3RV2011-1KA10
	4	4								0AE21-8CA0
FSC	5.5	5.5	0BE21-8AA0	0CE21-8AA0	0AE23-8CA0	1AC00-0VA0	0BE23-8BA0	32	3NA3812	3RV2021-4BA10
FSD	7.5	7.5	0BE23-8AA0	0CE23-8AA0		1AD00-0VA0		63	3NA3822	3VL1103-1KM30-0AA0
	11	11			3VL1104-1KM30-0AA0					
	15	15			3VL1105-1KM30-0AA0					
			6SE6400-...	6SL3203-...	6SE6400-...	6SL3266-...	6SL3203-...			
FSE	22	18.5	4BD21-2DA0	0CJ24-5AA0	3TC05-4DD0	1AE00-0VA0	0BE27-5BA0	63	3NA3024	3VL1108-1KM30-0AA0
	30	22		0CD25-3AA0	3TC03-8DD0					80

Selecting SIMATIC S7-1200 PLC for SINAMICS V20

CPU	Article number		Communication module	
			RS485 communication for USS or MODBUS RTU	Article number
CPU 1211C	1211 CPU AC/DC/Rly	6ES7 211-1BE40-0XB0	CB 1241 RS 485 or CM 1241 RS 485/422	6ES7241-1CH30-1XB0 or 6ES7241-1CH32-0XB0
	1211 CPU DC/DC/DC	6ES7 211-1AE40-0XB0		
	1211 CPU DC/DC/Rly	6ES7 211-1HE40-0XB0		
CPU 1212C	1212 CPU AC/DC/Rly	6ES7 212-1BE40-0XB0		
	1212 CPU DC/DC/DC	6ES7 212-1AE40-0XB0		
	1212 CPU DC/DC/Rly	6ES7 212-1HE40-0XB0		
CPU 1214C	1214 CPU AC/DC/Rly	6ES7 214-1BG40-0XB0		
	1214 CPU DC/DC/DC	6ES7 214-1AG40-0XB0		
	1214 CPU DC/DC/Rly	6ES7 214-1HG40-0XB0		
CPU 1215C	1215 CPU AC/DC/Rly	6ES7 215-1BG40-0XB0		
	1215 CPU DC/DC/DC	6ES7 215-1AG40-0XB0		
	1215 CPU DC/DC/Rly	6ES7 215-1HG40-0XB0		
CPU 1217C	1217 CPU DC/DC/DC	6ES7 217-1AG40-0XB0		

The shown SIMATIC S7 selection is only a suggestion. For detailed and further information, please refer to the SIMATIC S7-1200 brochure, catalog or web page: <http://siemens.com/simatic-s7-1200>

System at glance

SINAMICS V20

3AC 380 V ... 480 V

1AC 200 V ... 240 V

1AC 200 V ... 240 V



FSA

FSAB

FSA

FSB

FSC

FSD

FSE



SINAMICS V20 BOP
(Basic Operator Panel)



SINAMICS V20
BOP interface



SINAMICS V20
Smart Access



SINAMICS V20
Parameter loader



SINAMICS V20
Braking module

SINAMICS V20 – Options



Braking resistor



Line reactor



Output reactor

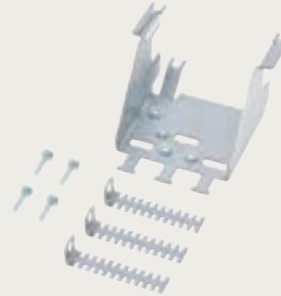

Shield connection kit

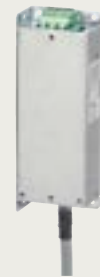

Line filter



Standard fuse



Circuit breaker



Replacement fan



Standard LAN cable

There's more to it:
siemens.com/ids

**Discover in detail how
Integrated Drive Systems boost
your competitive edge and
improve your time to profit.**

Integrated
Drive Systems
to go: Visit our
mobile site!



Follow us on:
www.twitter.com/siemensindustry
www.youtube.com/siemens

**Published by
Siemens AG 2016**

Digital Factory
P.O. Box 31 80
91050 Erlangen, Germany

Article No. E20001-A90-P670-V9-7600
Printed in Germany
Dispo 21500
WÜ/1722 WS 01173.0

Subject to changes and errors.

The information given in this document only contains general descriptions and/or performance features which may not always specifically reflect those described, or which may undergo modification in the course of further development of the products. The requested performance features are binding only when they are expressly agreed upon in the concluded contract.

For the secure operation of Siemens products and solutions, it is necessary to take suitable preventive action (e.g. cell protection concept) and integrate each component into a holistic, state-of-the-art industrial security concept. Third-party products that may be in use should also be considered. For more information about industrial security, visit <http://www.siemens.com/industrialsecurity>